

Assembly Instructions

Hampstead Garden Natural Rattan
Large Armchair and Coffee Table Set

521204-01-01
CLHNRLACT

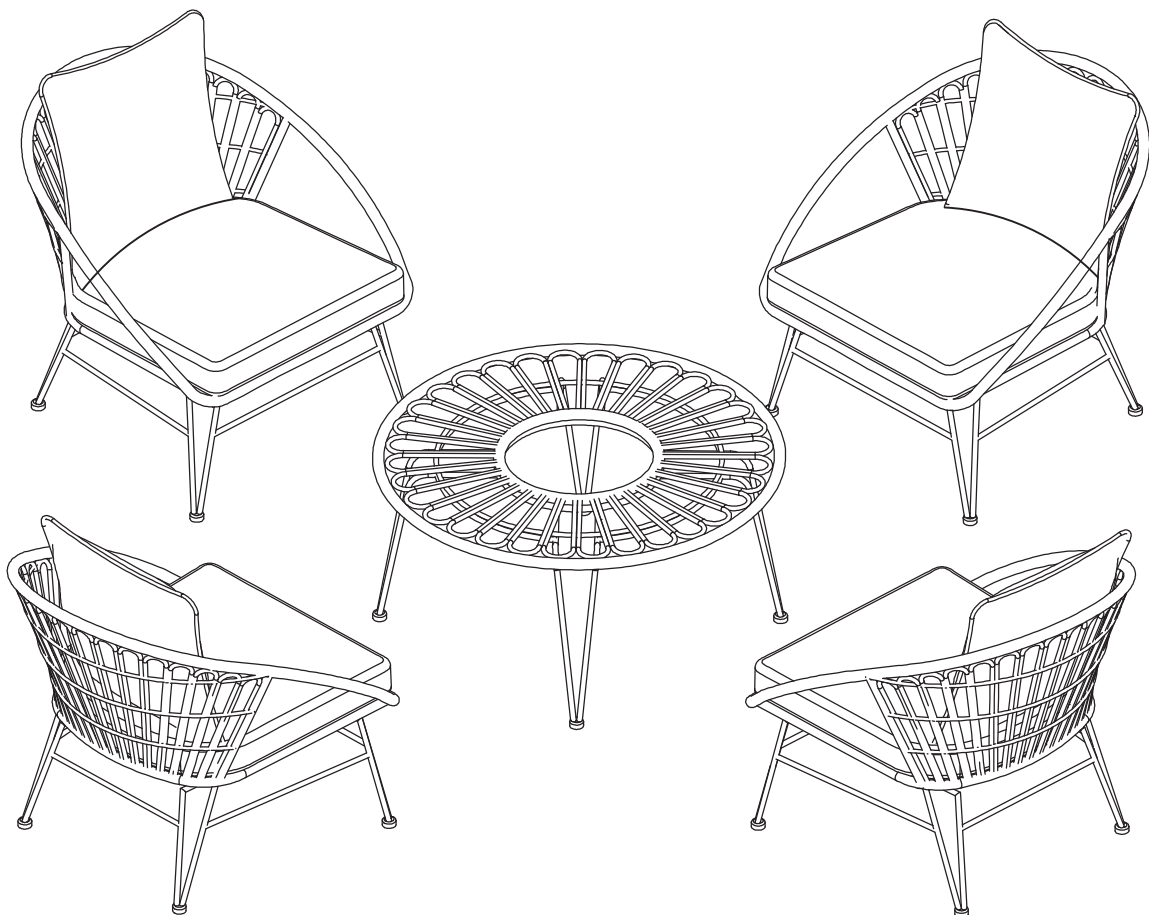

Keep these instructions for future reference

Assemble the furniture on a soft level surface to avoid damaging the furniture or your floor.

We recommend furniture be assembled near where they will be placed, to avoid moving the product unnecessarily once assembled.

If there is a need to move the furniture, please remove all loose items and have extra hands to help lift the furniture to the desired location. Dragging the furniture will damage both the furniture and the floor.

Regularly check and re-tighten (if necessary) all bolts on furniture that you have assembled yourself.

OUTDOOR FURNITURE CARE:

Clean using water and a soft brush.

Do not use aggressive cleaning agents and abrasives.

Remove any spilled food and drinks as soon as possible to prevent permanent staining.

Do not attempt to clean furniture in direct sunlight on a hot day.

Wash either in the morning or evening.

CUSHION

Sponge clean cushions only. For stubborn stains, fabric cleaners are commercially available. Please review application instructions on product before using on your cushions.

WARNING REGARDING TEMPERED GLASS!

Do not strike glass with hard or pointed items Do not use the glass as a chopping surface

Do not sit or stand upon glass surface(s)

Do not place very hot – or very cold items in direct contact with the glass surfaces(s)

Only clean glass using a damp cloth with washing up liquid or soft soap, do not use any substances containing abrasives since they scratch the glass
If the glass is chipped or broken, stop using the product and consult store

PARTS AND HARDWARE

Avoid using sharp objects such as a knife to cut open packing as you may accidentally damage the upholstery.

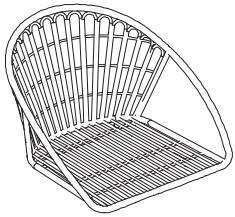

A: 4PCS

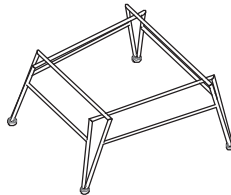

B: 4PCS

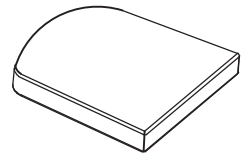

C: 4PCS

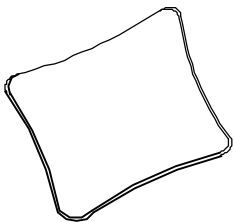

D: 4PCS

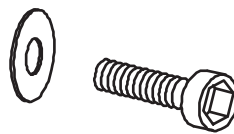

E: 28SETS



F: 1PC

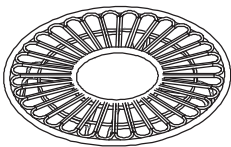

G: 1PC



H: 4PCS

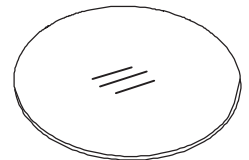

I: 1PCS

1

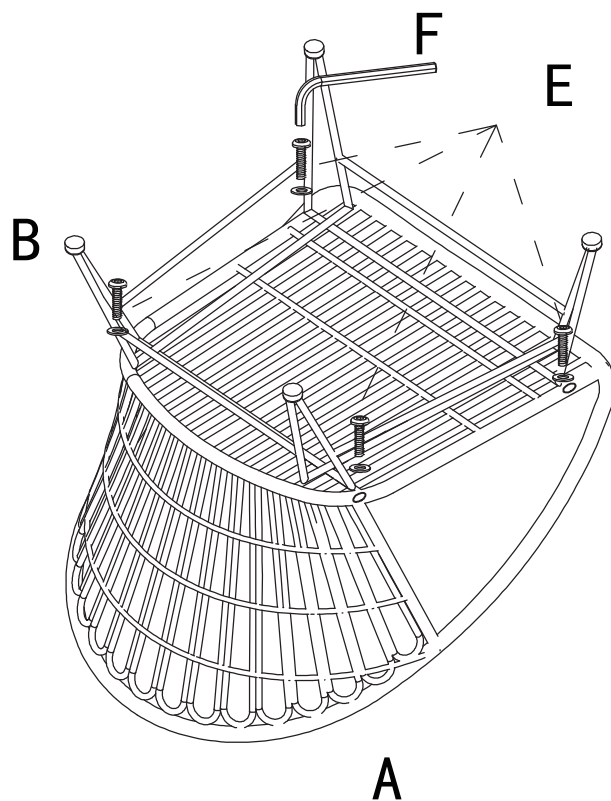

X 4

Fully tighten bolts only after all bolts on each leg are installed.

2

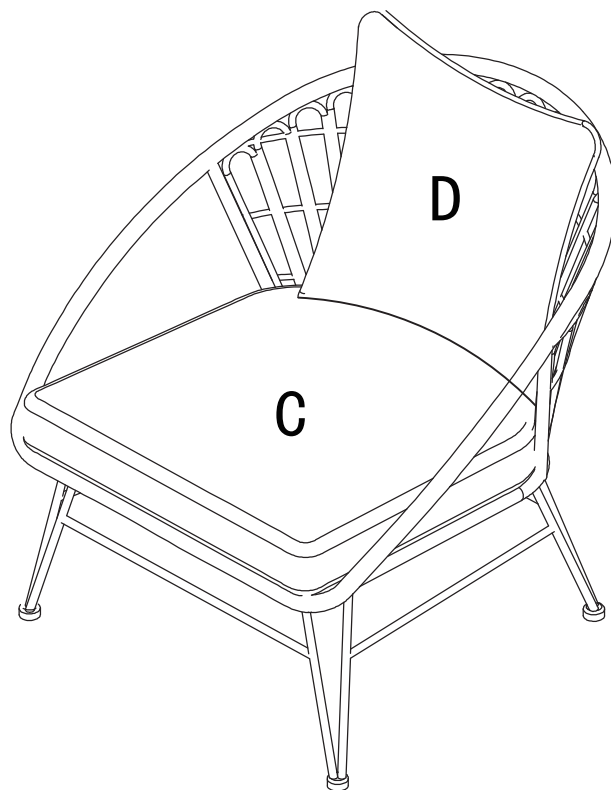

X 4

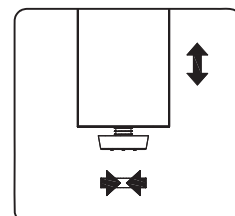

4-5

3

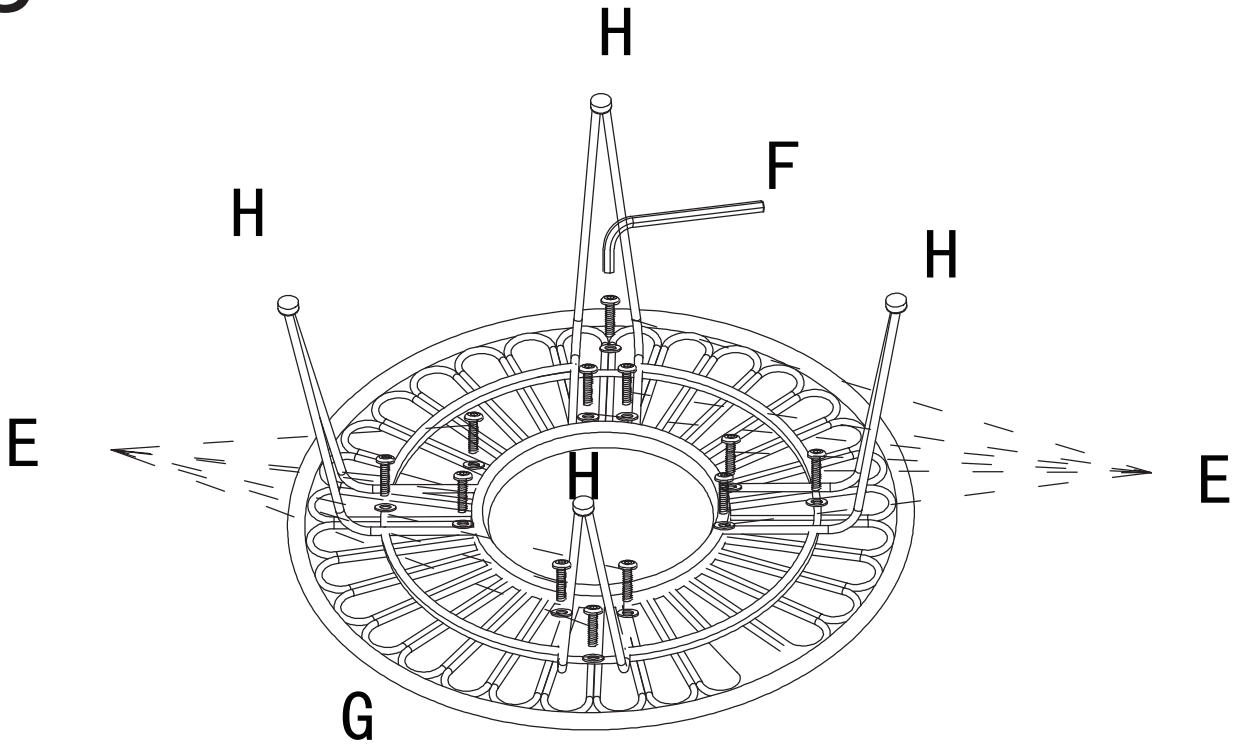

4

